

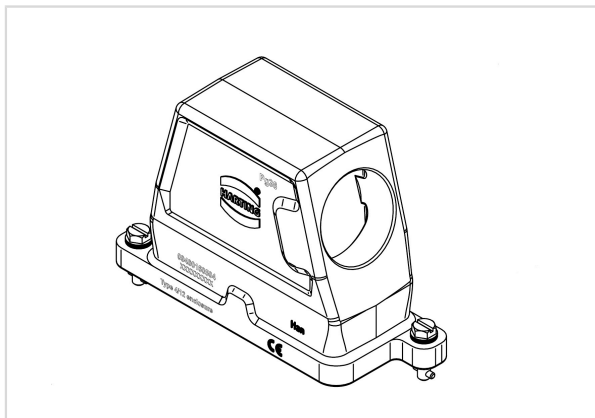

Pushing Performance
Since 1945

Product Declaration Certificate



Part number	09 40 016 0504
Specification	Han 16 HPR Hood Side Entry PG 36 Toggle

RoHS	compliant
ELV status	compliant
China RoHS	e
REACH Annex XVII substances	Not contained
REACH ANNEX XIV substances	Not contained
REACH SVHC substances	Not contained
California Proposition 65 substances	Yes
California Proposition 65 substances	Nickel

RoHS: Directive 2011/65/EU with all amending directives and regulations in force at the declaration's creation date.

ELV status: Directive 2000/53/EC with all amending directives and regulations in force at the declaration's creation date.

REACH ANNEX: Regulation (EU) No. 1907/2006 with all amending directives and regulations in force at the declaration's creation date.

REACH SVHC substances: We applied "Candidate List of substances of very high concern for Authorisation" of ECHA valid on the declaration's creation date.

ECHA SCIP: Article notification number in the SCIP Data base of the European Chemicals Agency (ECHA) according to Waste Frame Directive 2008/89/EC with amended directive 2018/851 in Article 9